

ACCU-TRAC[®]

ATTACHMENT SYSTEMS

TYPICAL DETAILS

PRESSURE EQUALIZED RAIN SCREEN SYSTEM

(DS SYSTEM)

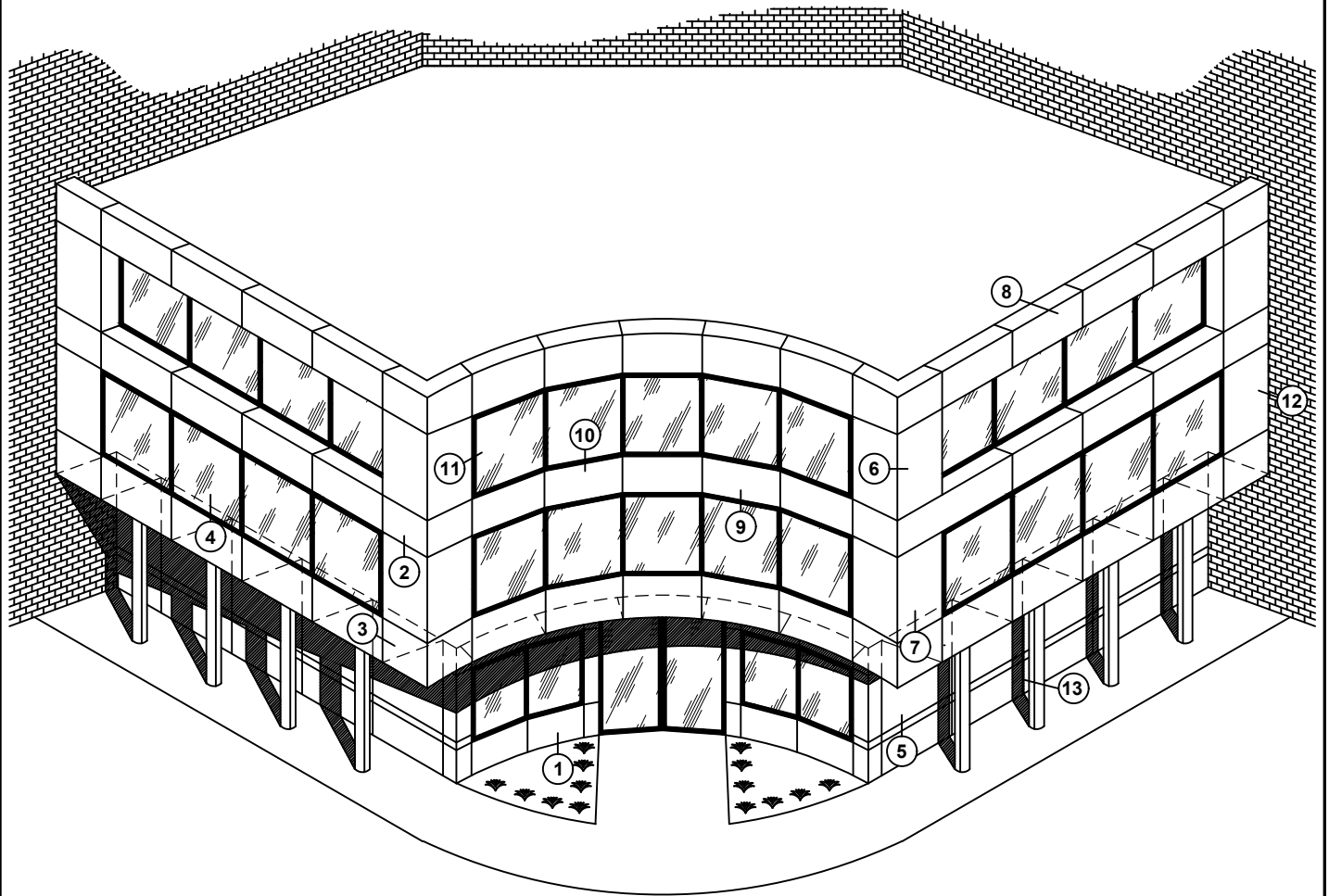

MANUFACTURED BY ALTECH PANEL SYSTEMS AND AVAILABLE THROUGH VARIOUS DISTRIBUTORS
1 JOHNSON ST. SUITE 118 CARTERSVILLE, GA. 30120 PHONE 678-721-4569

ALTECHPANEL.COM

ACCU-TRAC® (DS) ATTACHMENT SYSTEMS

1 JOHNSON ST. SUITE 118 CARTERSVILLE, GA. 30120 PHONE 678-721-4569

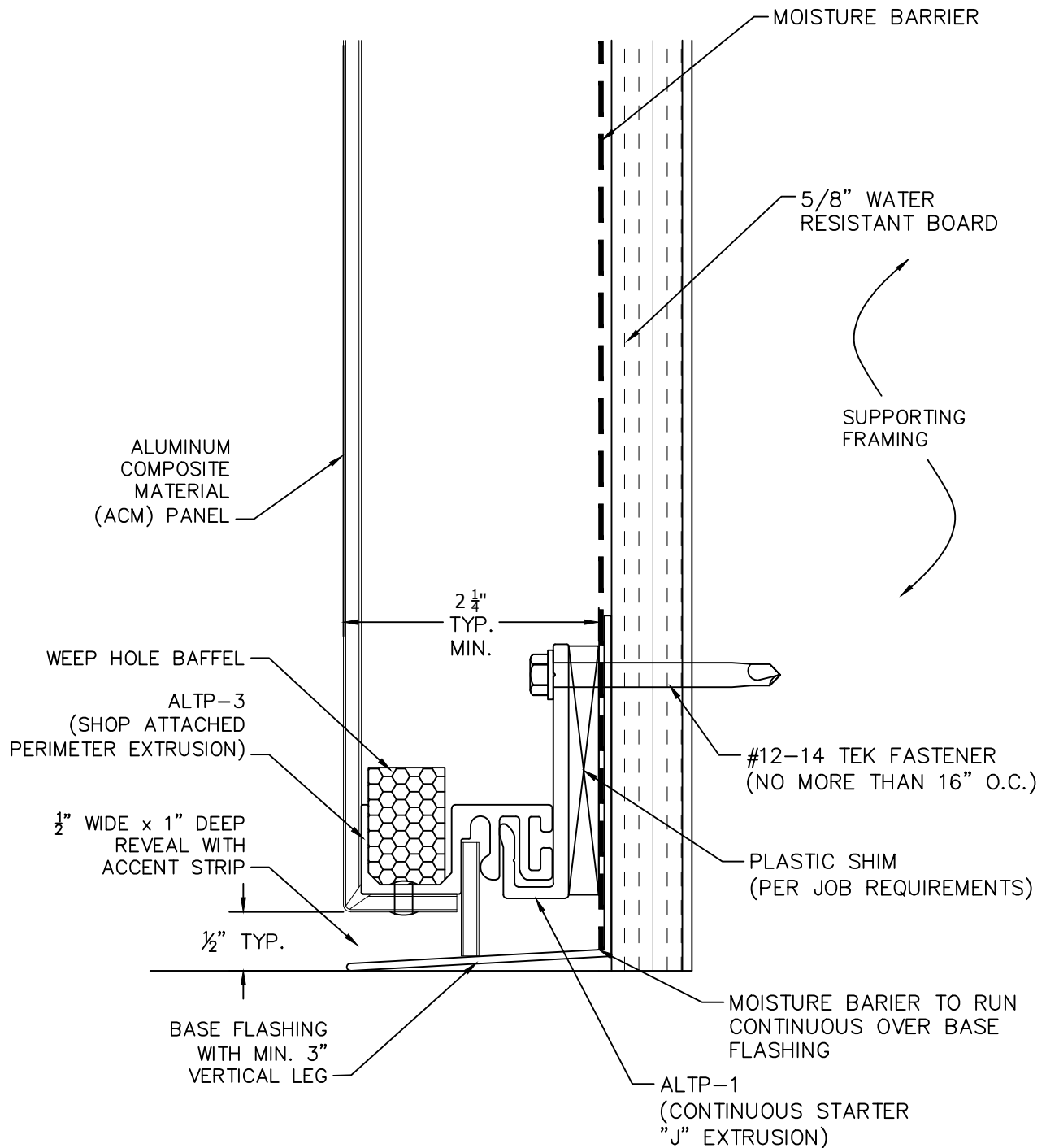

1

SILL TERMINATION

SCALE: NONE

ACCU-TRAC® (DS) ATTACHMENT SYSTEMS

1 JOHNSON ST. SUITE 118 CARTERSVILLE, GA. 30120 PHONE 678-721-4569

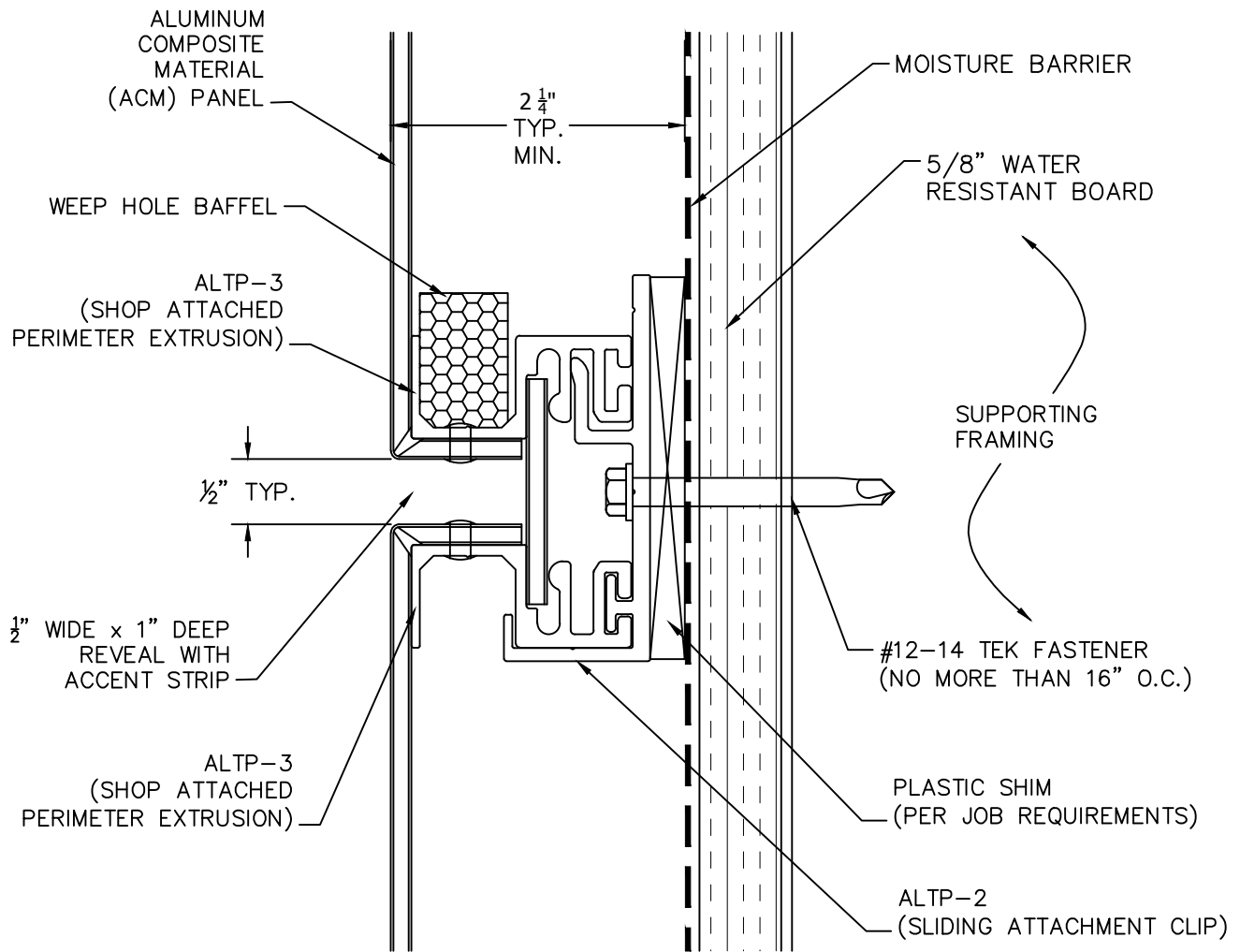

2

TYP. HORIZONTAL JT.
SCALE: NONE

ACCU-TRAC® (DS) ATTACHMENT SYSTEMS

1 JOHNSON ST. SUITE 118 CARTERSVILLE, GA. 30120 PHONE 678-721-4569

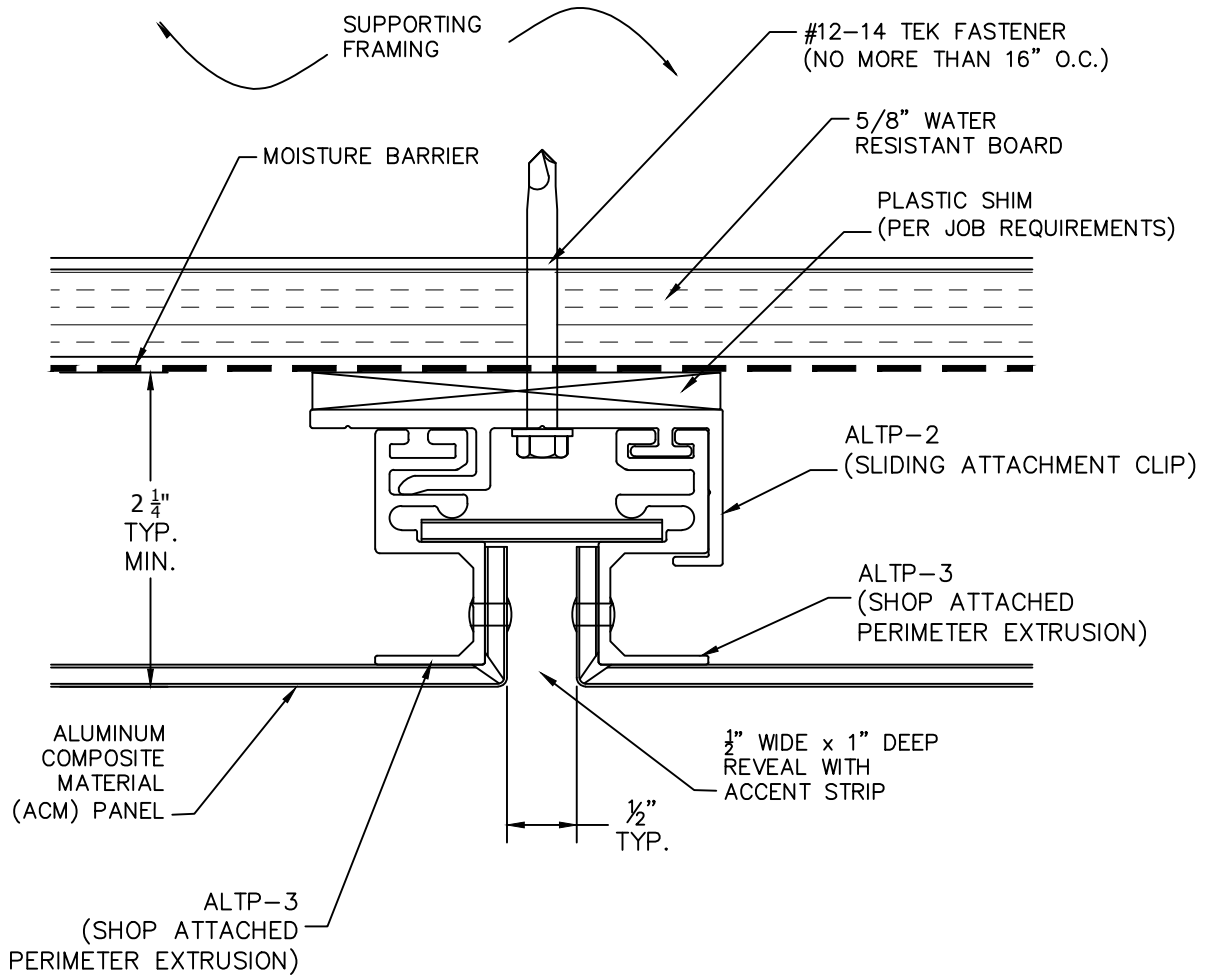

3

TYP. VERTICAL JT.
SCALE: NONE

ACCU-TRAC® (DS) ATTACHMENT SYSTEMS

1 JOHNSON ST. SUITE 118 CARTERSVILLE, GA. 30120 PHONE 678-721-4569

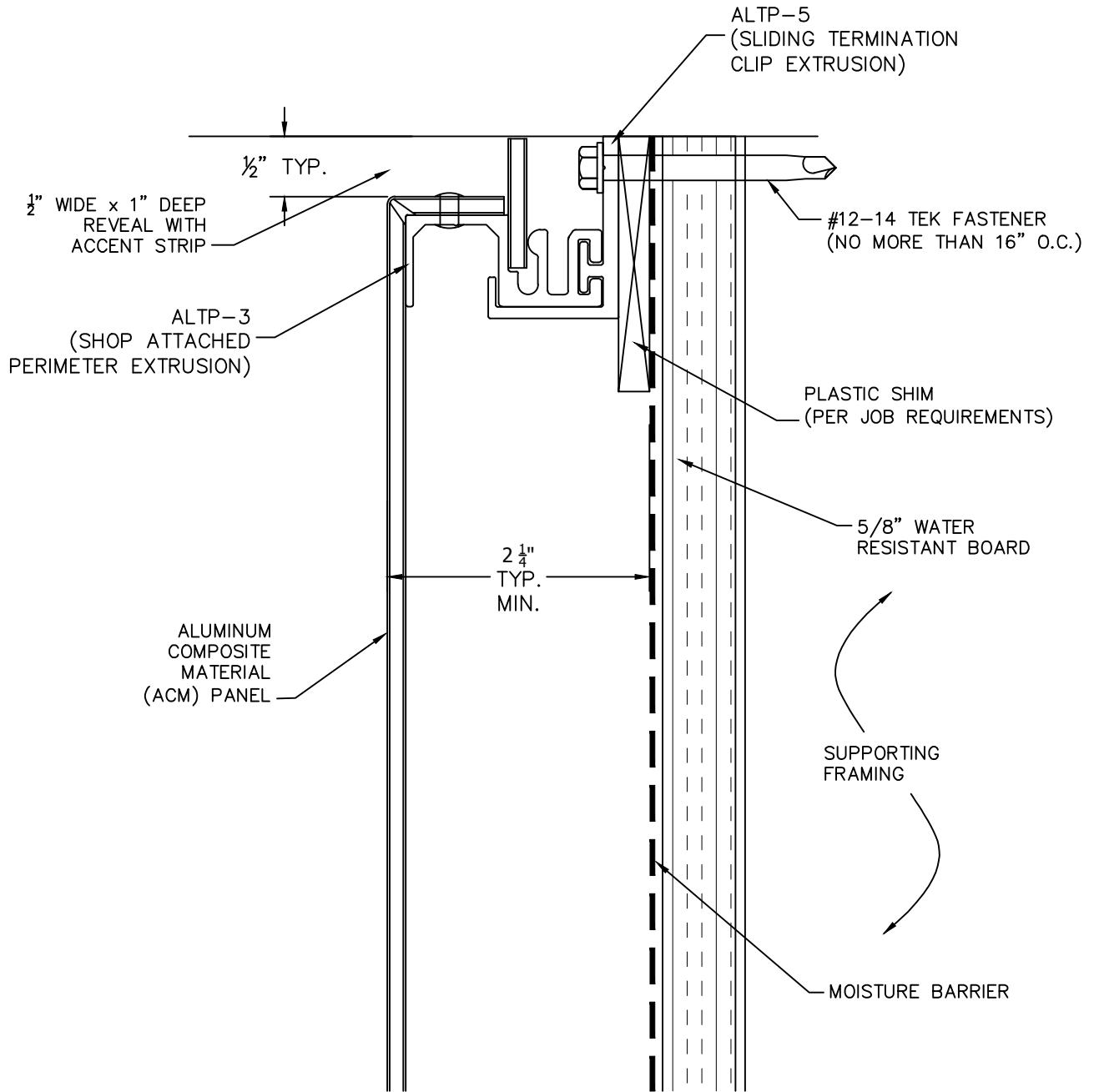

4

HEAD TERMINATION

SCALE: NONE

ACCU-TRAC® (DS) ATTACHMENT SYSTEMS

1 JOHNSON ST. SUITE 118 CARTERSVILLE, GA. 30120 PHONE 678-721-4569

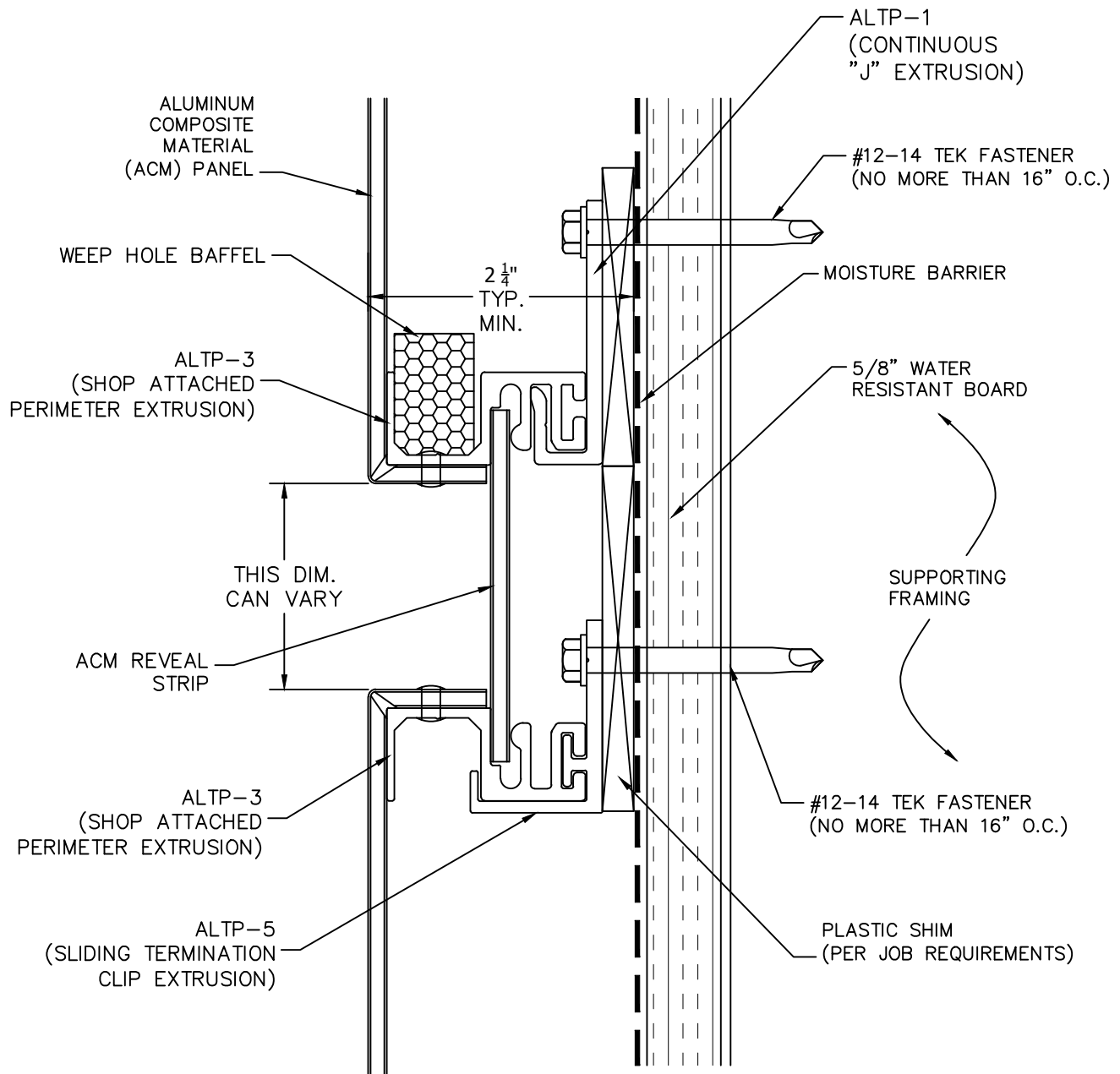

5

TYP. REVEAL JT.
SCALE: NONE

ACCU-TRAC® (DS) ATTACHMENT SYSTEMS

1 JOHNSON ST. SUITE 118 CARTERSVILLE, GA. 30120 PHONE 678-721-4569

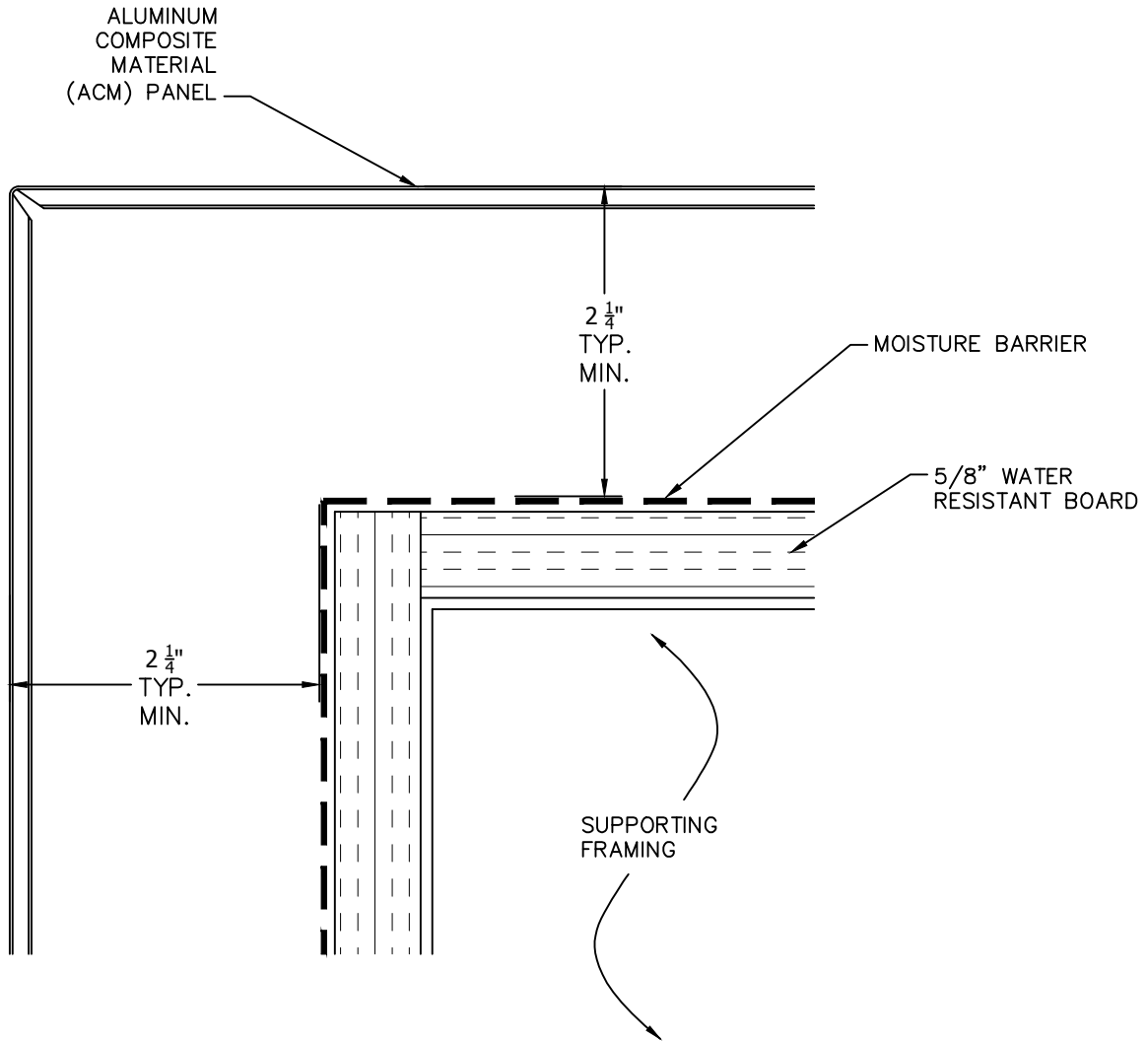

6 OUTSIDE CORNER
SCALE: NONE

ACCU-TRAC® (DS) ATTACHMENT SYSTEMS

1 JOHNSON ST. SUITE 118 CARTERSVILLE, GA. 30120 PHONE 678-721-4569

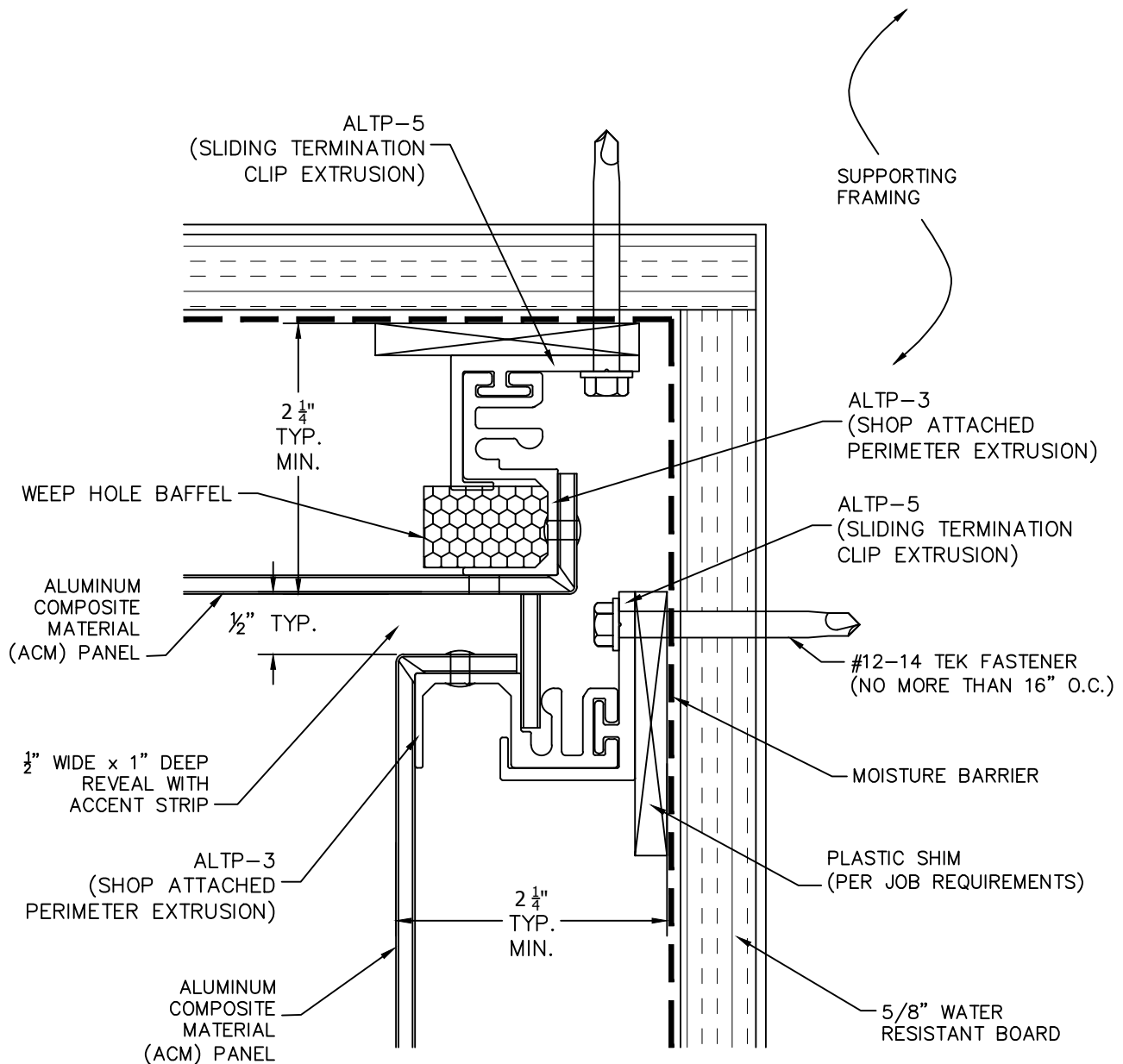

7

SOFFIT CONDITION

SCALE: NONE

ACCU-TRAC® (DS) ATTACHMENT SYSTEMS

1 JOHNSON ST. SUITE 118 CARTERSVILLE, GA. 30120 PHONE 678-721-4569

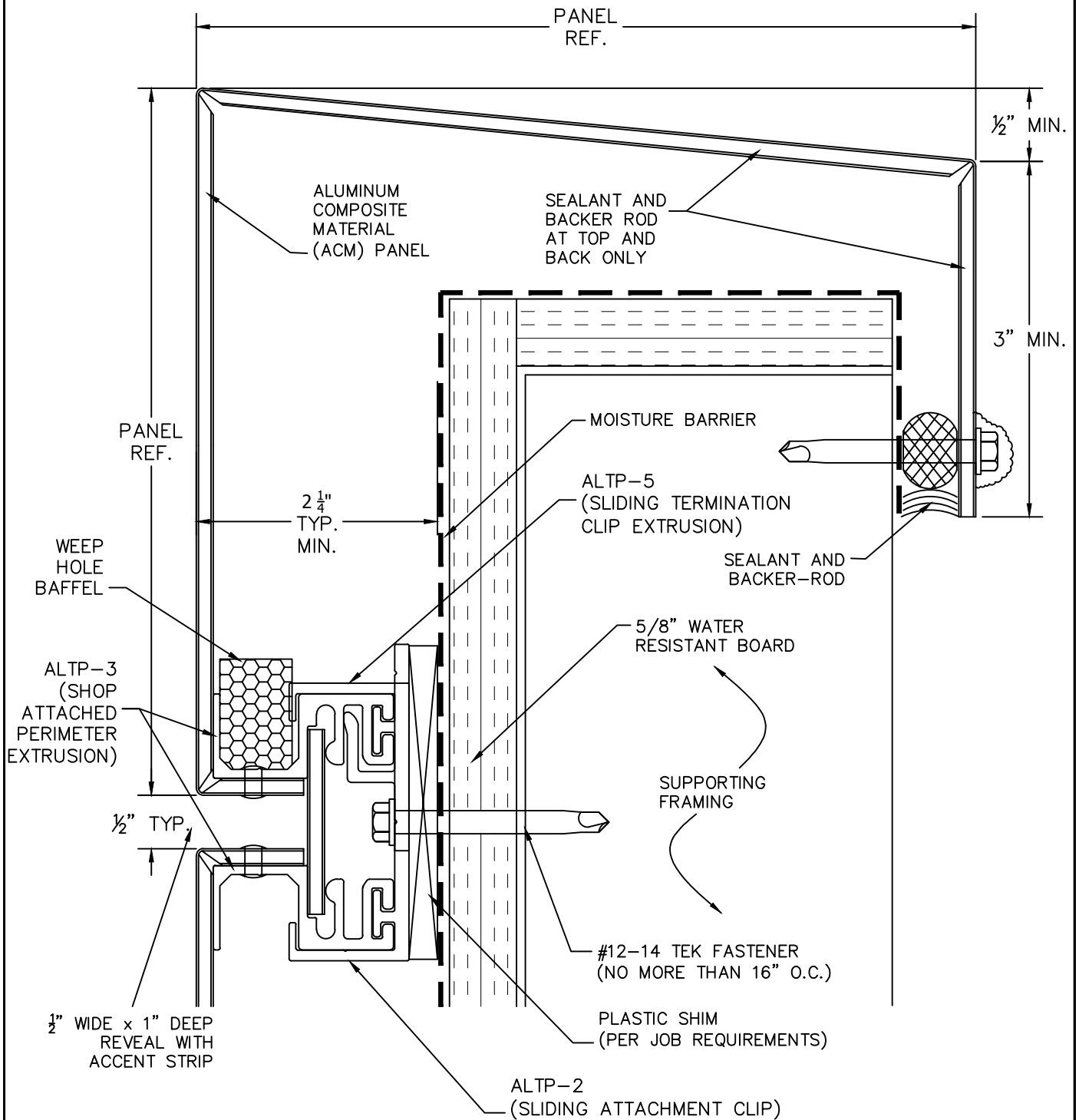

8

PARAPET CONDITION

SCALE: NONE

ACCU-TRAC® (DS) ATTACHMENT SYSTEMS

1 JOHNSON ST. SUITE 118 CARTERSVILLE, GA. 30120 PHONE 678-721-4569

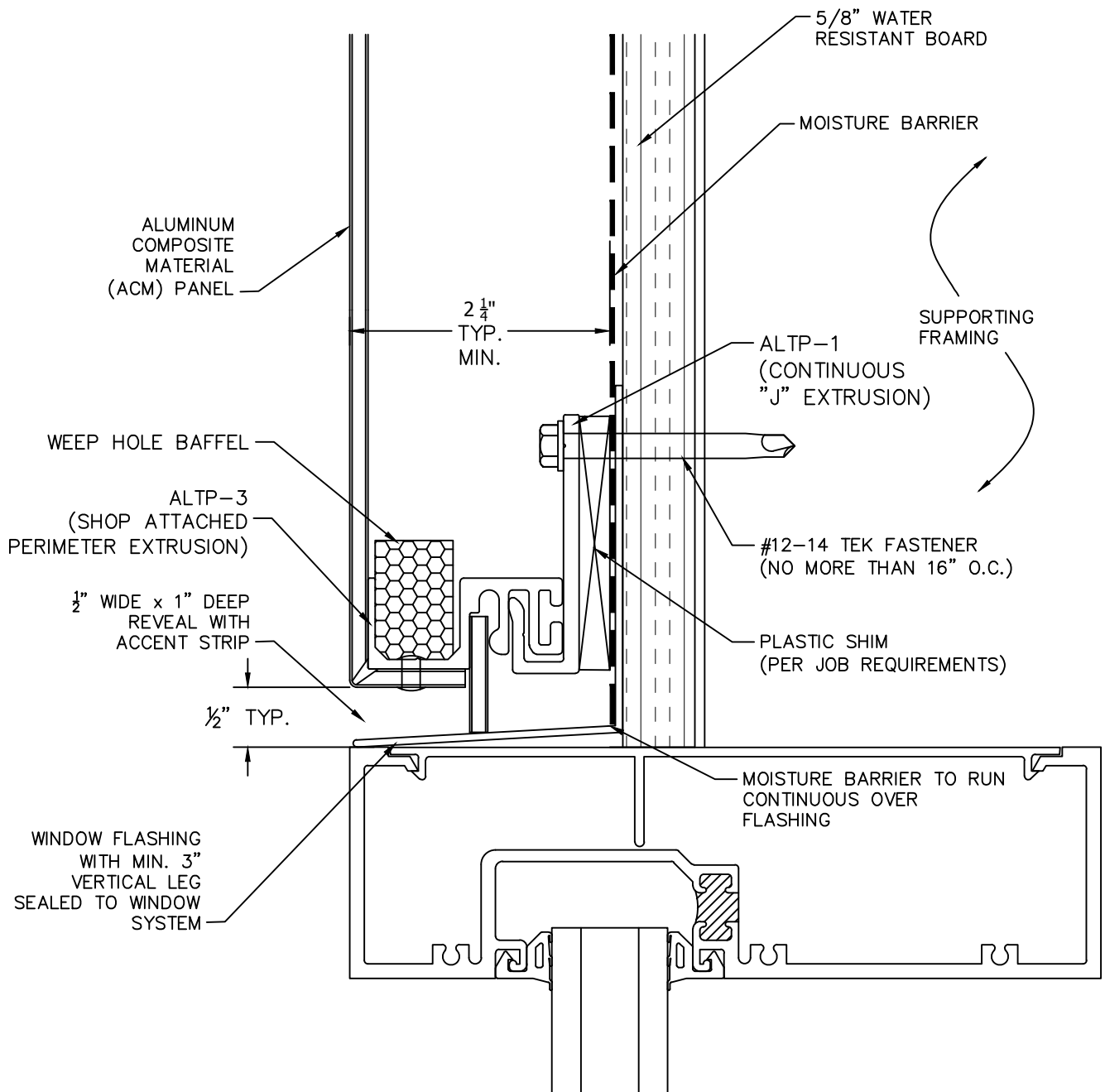

9

WINDOW HEAD CONDITION

SCALE: NONE

ACCU-TRAC® (DS) ATTACHMENT SYSTEMS

1 JOHNSON ST. SUITE 118 CARTERSVILLE, GA. 30120 PHONE 678-721-4569

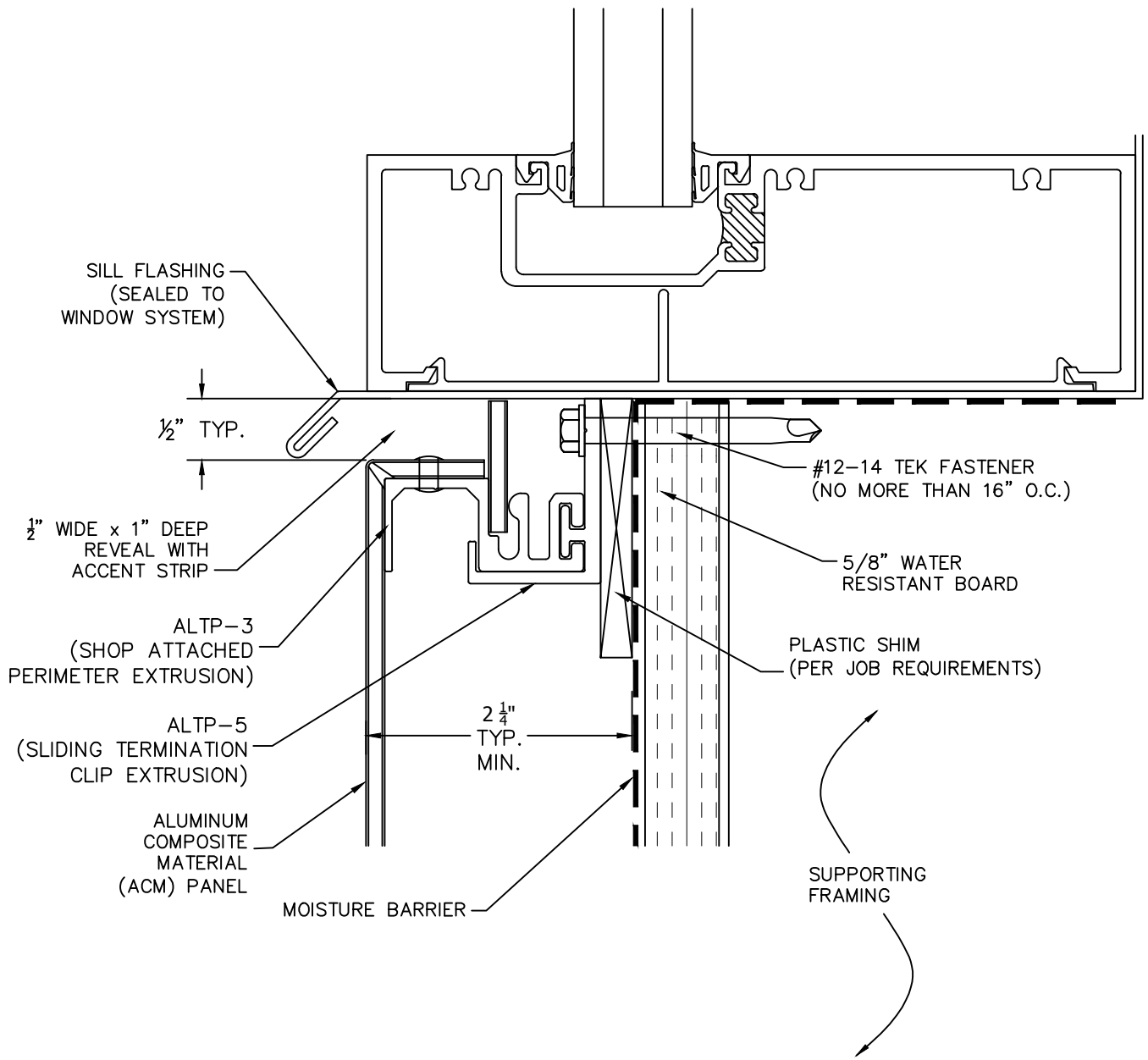

10

WINDOW SILL CONDITION
SCALE: NONE

ACCU-TRAC® (DS) ATTACHMENT SYSTEMS

1 JOHNSON ST. SUITE 118 CARTERSVILLE, GA. 30120 PHONE 678-721-4569

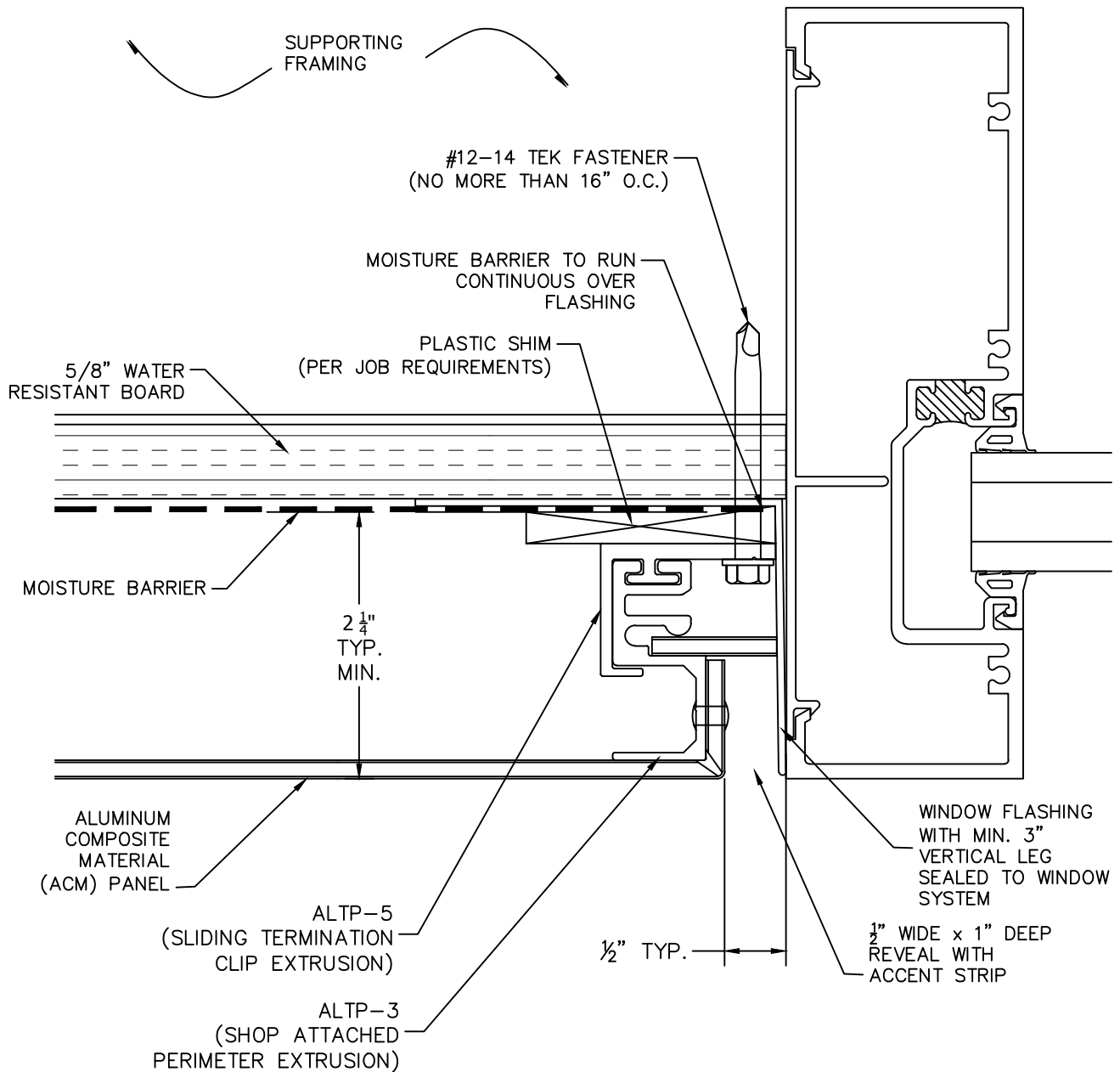

11

WINDOW JAMB CONDITION

SCALE: NONE

ACCU-TRAC® (DS) ATTACHMENT SYSTEMS

1 JOHNSON ST. SUITE 118 CARTERSVILLE, GA. 30120 PHONE 678-721-4569

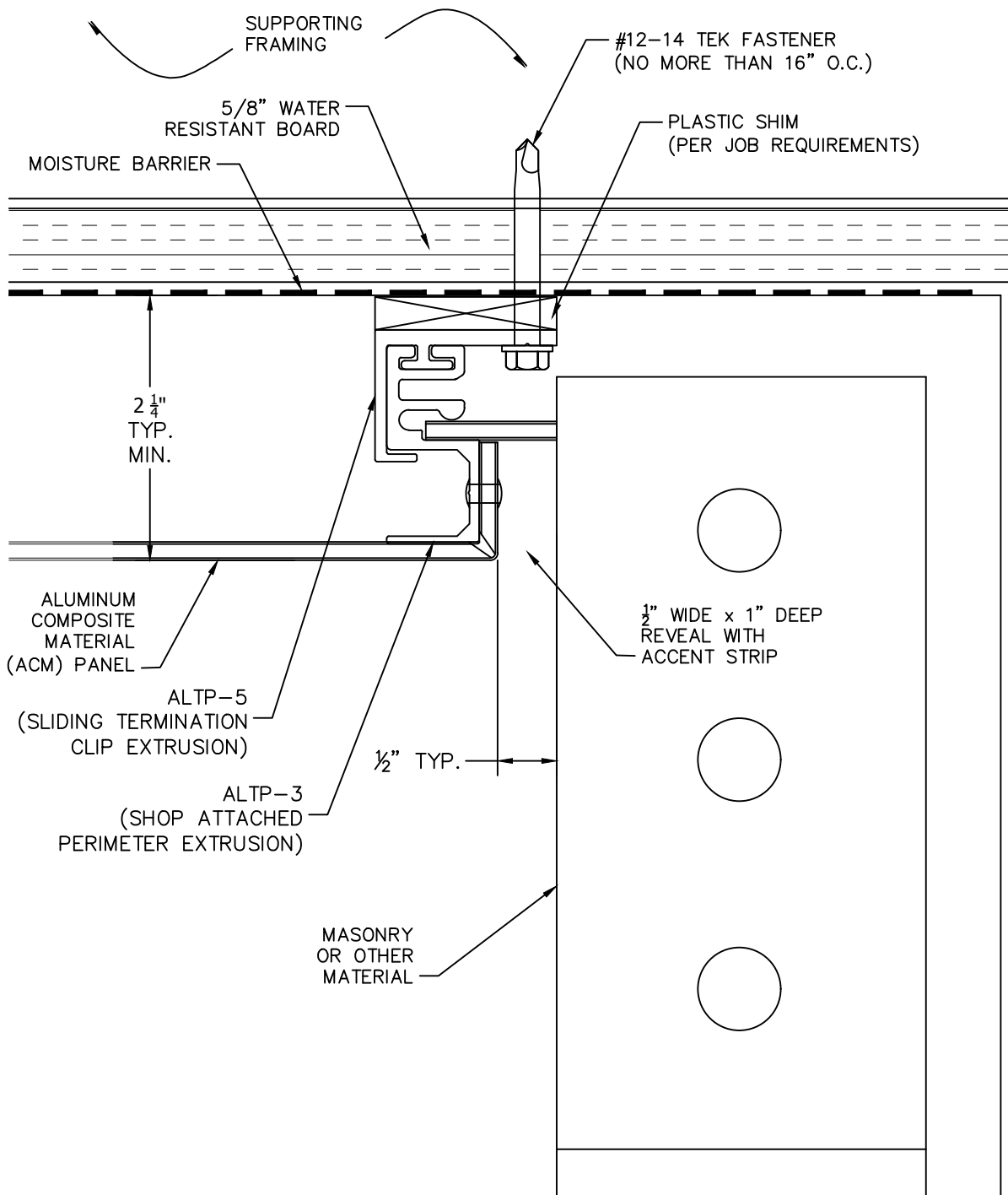

12

JAMB CONDITION @ BRICK
SCALE: NONE

ACCU-TRAC® (DS) ATTACHMENT SYSTEMS

1 JOHNSON ST. SUITE 118 CARTERSVILLE, GA. 30120 PHONE 678-721-4569

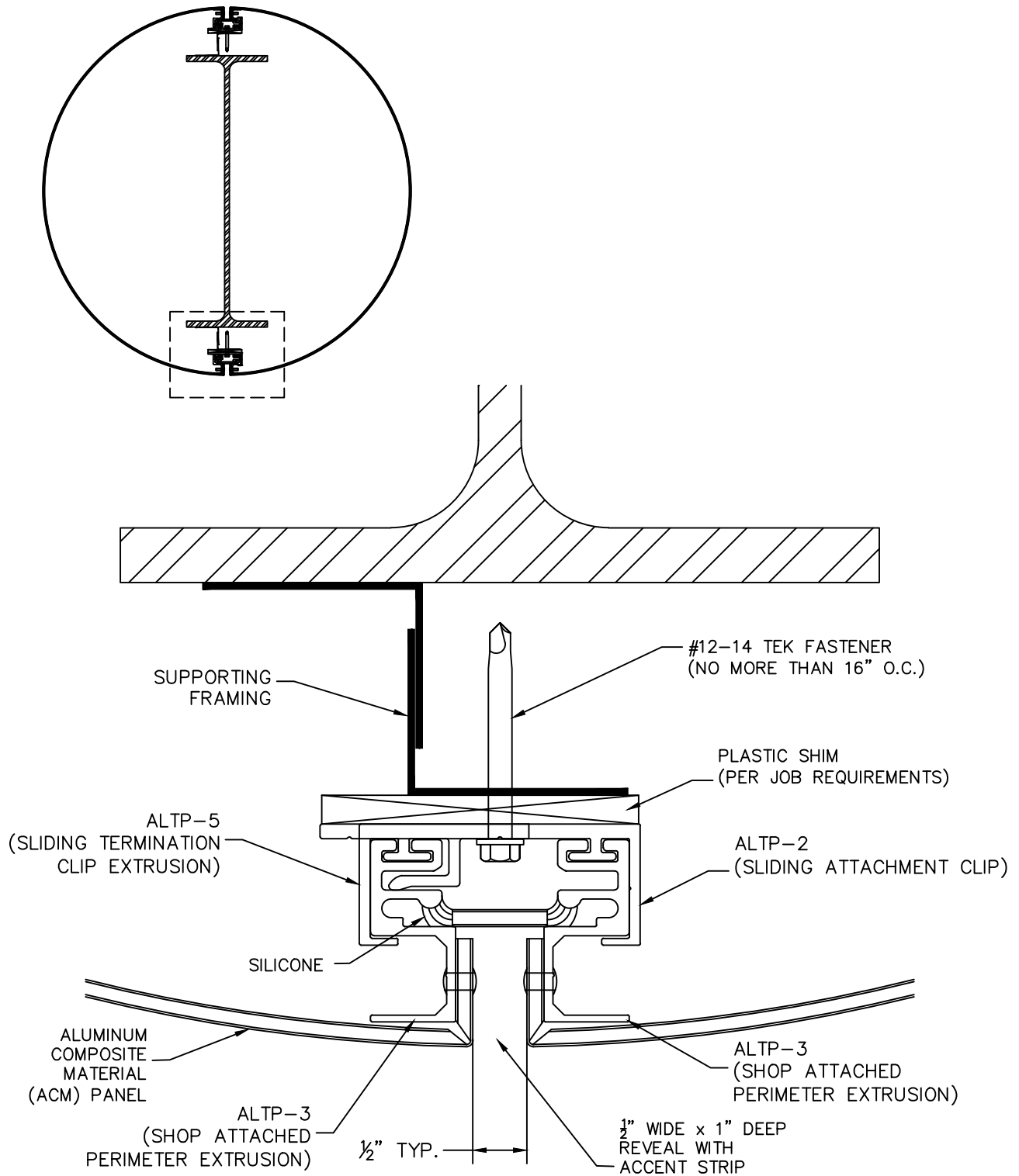

13

COLUMN DETAIL

SCALE: NONE